



Finally, the answer you've been looking for is here

A-TAP SERIES

Volume 8



INDEX

Blind Hole

Metric

A-SFT	PAGE 8
A-OIL-SFT	PAGE 9
A-SFT-6GX	PAGE 10
A-SFT-7GX	PAGE 11
A-SFT FORM E	PAGE 12
A-SFT + 0.1	PAGE 13
A-LT-SFT	PAGE 14
A-SFT-LH	PAGE 15
A-SFT-HB Weldon Shank	PAGE 16

Metric Fine

A-SFT	PAGE 17
A-OIL-SFT	PAGE 18
A-SFT-6GX	PAGE 19

UNC

A-SFT	PAGE 20
-------------	---------

UNF

A-SFT	PAGE 21
-------------	---------

G (BSP)

A-SFT	PAGE 22
-------------	---------

BSW

A-SFT	PAGE 23
-------------	---------

BSF

A-SFT	PAGE 24
-------------	---------

BA

A-SFT	PAGE 25
-------------	---------

Rc (BSPT)

A-TPT	PAGE 26
-------------	---------

Rc (ISO)

A-SFT Rc	PAGE 27
----------------	---------

Through Hole

Metric

A-POT NEW SIZES	PAGE 28
A-OIL-POT	PAGE 29
A-POT-6GX	PAGE 30
A-POT-7GX	PAGE 31
A-POT + 0.1	PAGE 32
A-LT-POT	PAGE 33
A-POT-LH	PAGE 34
A-POT-HB Weldon Shank	PAGE 35

Metric Fine

A-POT	PAGE 36
A-OIL-POT	PAGE 37
A-POT-6GX	PAGE 38

UNC

A-POT	PAGE 39
-------------	---------

UNF

A-POT	PAGE 40
-------------	---------

G (BSP)

A-POT	PAGE 41
-------------	---------

BSW

A-POT	PAGE 42
-------------	---------

BSF

A-POT	PAGE 43
-------------	---------

BA

A-POT	PAGE 44
-------------	---------

Finally, the answer you've been looking for is here...

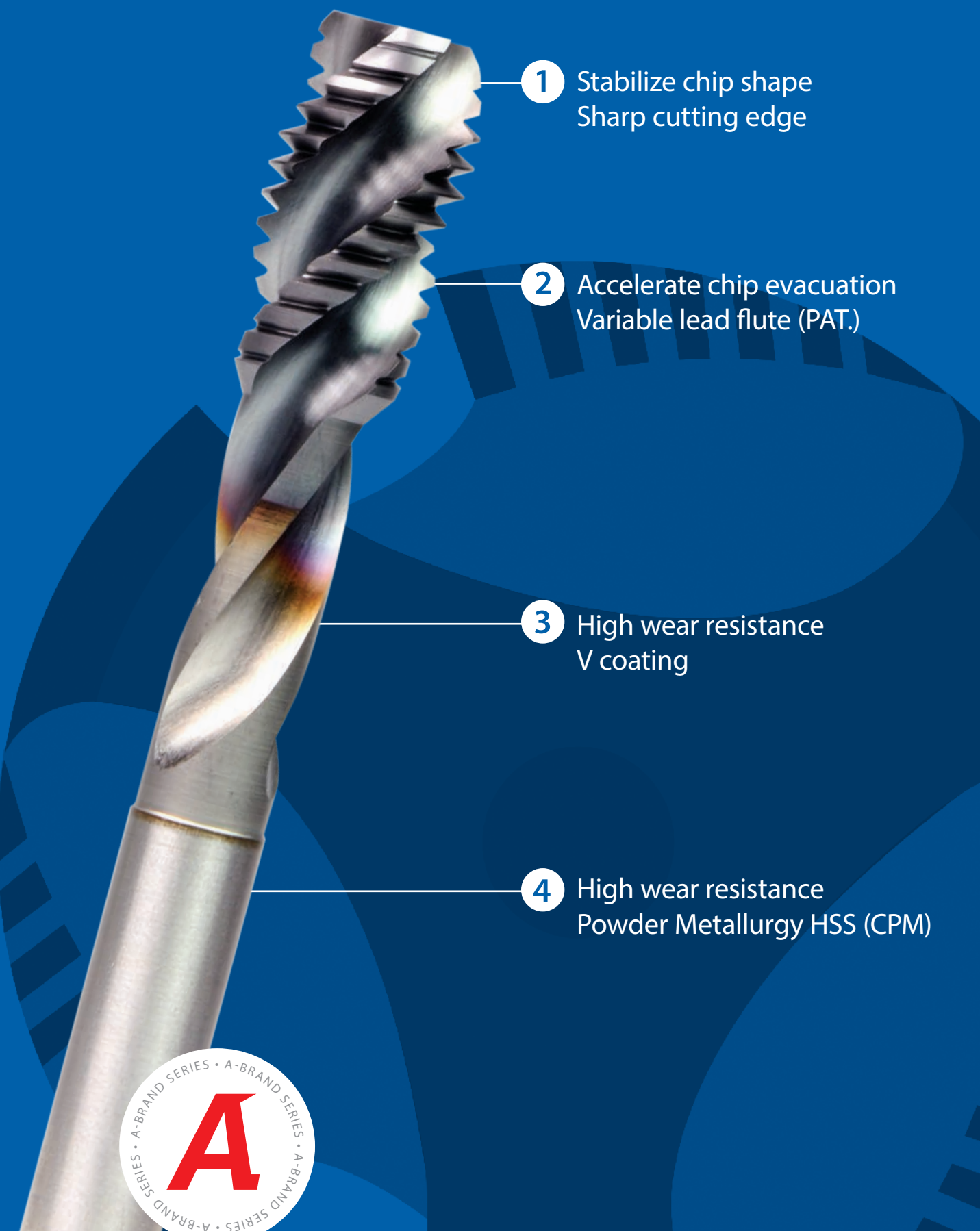
- 
- 1 Stabilize chip shape
Sharp cutting edge
 - 2 Accelerate chip evacuation
Variable lead flute (PAT.)
 - 3 High wear resistance
V coating
 - 4 High wear resistance
Powder Metallurgy HSS (CPM)



OSG'S NEW PREMIUM BRAND "A-TAP SERIES"

The answer for your troubles lies here

Most of tapping troubles are caused by unstable chip evacuation.

A-TAP Series resolve such troubles and apply to a wide range of work materials and cutting speed.

Tapping Troubles

N°1 breakage and chipping	26 %
N°2 dimensional error	17 %
N°3 galling	14 %
Others	43 %

Main factor is chip packing

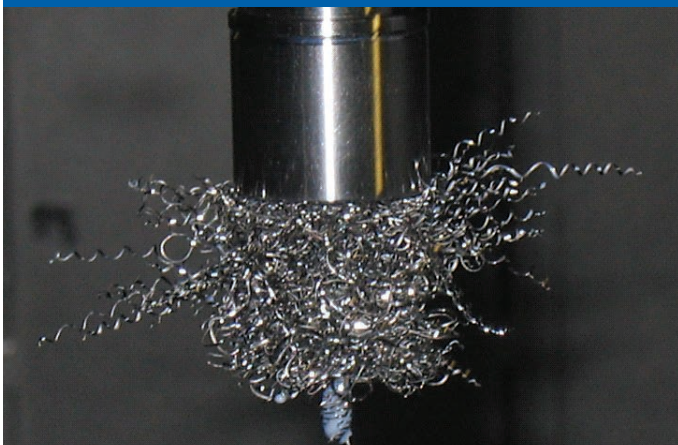

The biggest advantage of A-TAP Series:

THE BEST CHIP EVACUATION



Conventional Tap

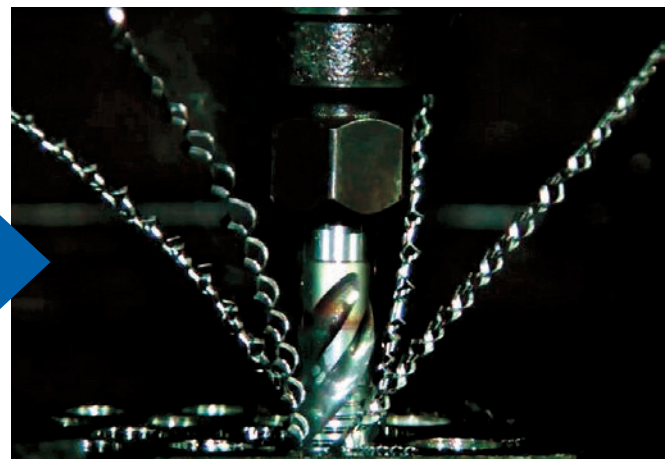

A-SFT

KEY FEATURES A-TAP SERIES

Applies to a wide variety of work materials

Even to mild steel and stainless steel



High performance in machining center

Applies to a wide cutting range

Long

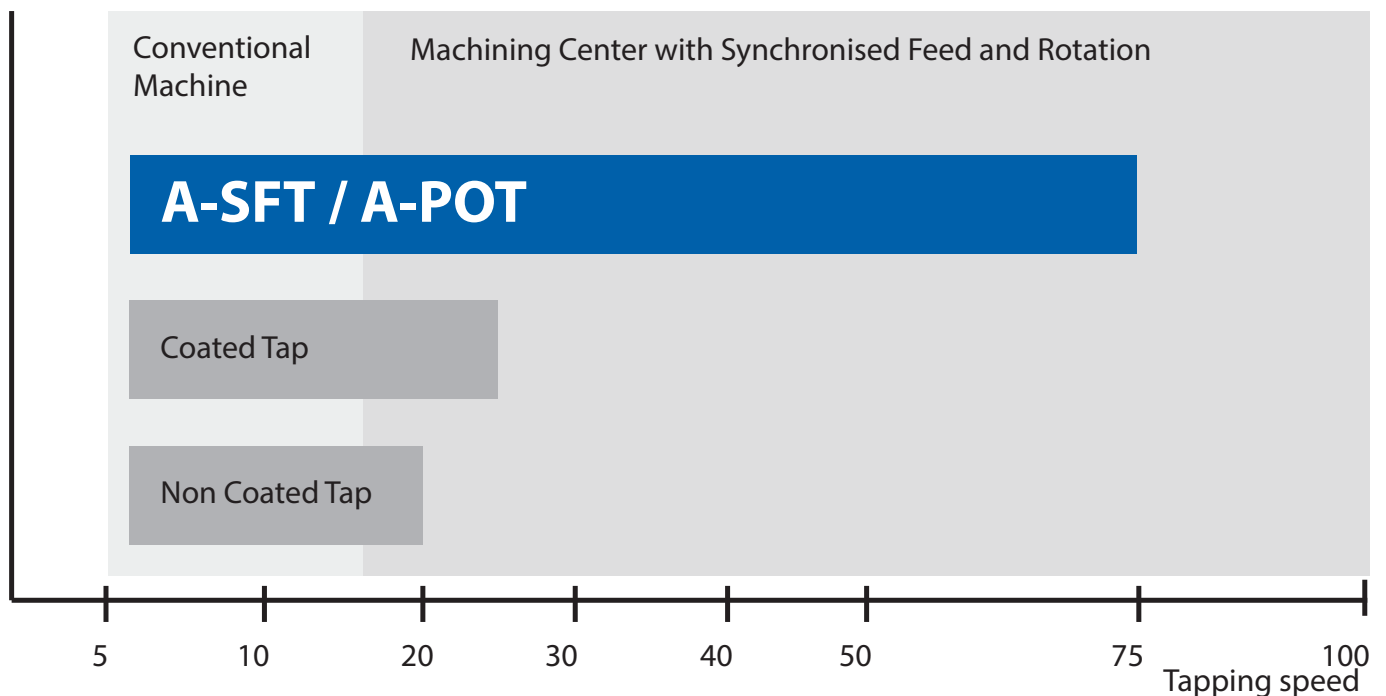

- It is a image of tapping in medium and high carbon steel with water soluble coolant.
- Machining center with synchronized feed and rotation is recommended for more than 15m/min.
- As the best speed varies by tapping condition, please find it by trials.

■ SUS304

Deep Hole Tapping (2D) in stainless steel

High performance achieved in stainless steel with water soluble oil



■ Cutting edge after 1.000 holes tapping

Tool	A-SFT M8x1,25
Work Material	SUS304
Hole Size	Ø6,8x22mm (Blind)
Tapping Length	16mm (2D)
Tapping Speed	10m/min (398min ⁻¹)
Coolant	Water Soluble Chlorine-Free (10%)
Machine	Vertical Synchronized Machining Center

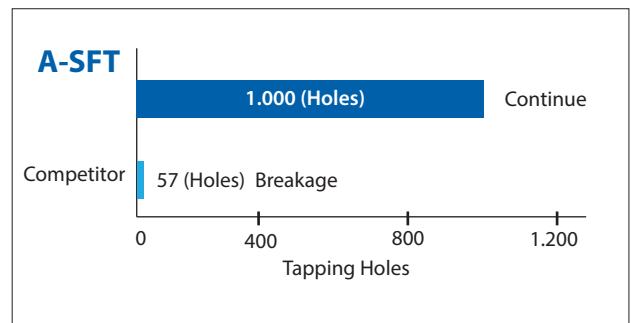

■ S45C

High speed tapping by machining center

Tapping operation in 15,30,40m/min are all stable

Tool	A-SFT M6x1
Work Material	S45C
Hole Size	Ø5x16mm (Blind)
Tapping Length	12mm (2D)
Coolant	Water Soluble Chlorine-Free (10%)
Machine	Vertical Synchronized Machining Center

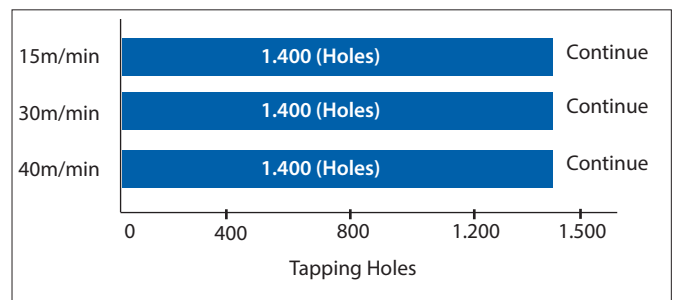

■ Cutting edge after 1.400 holes Tapping



■ Chip generated in 40m/min

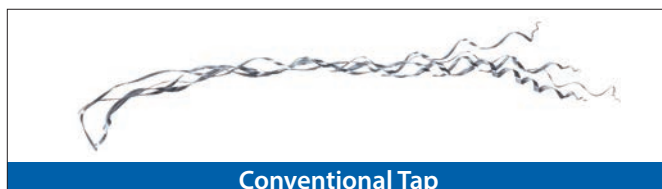

A-SFT

Threading | Cutting taps | Metric



- First choice in quality and performance
- Powder metal spiral-fluted cutting tap for blind holes
- Multilayer TiCN coating
- High speed tapping in general steels, aluminium, stainless steels

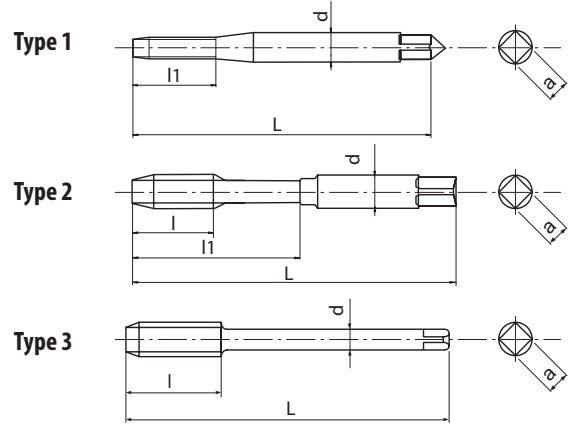

Threading | Cutting taps

P	P	P	P	M	N	N	S	H	
C < 0,2%	0,25 < C < 0,4	C > 0,45%	SCM	INOX	Al	AC,ADC	Ti	25-35 HRC	
15-60	15-60	10-60	8-30	8-20	15-35	15-35	5-10	8-20	m/min

A	M	PM	V	45°	ISO 2 6HX	C/2,5		DIN 371	DIN 376
----------	----------	-----------	----------	------------	------------------	--------------	--	----------------	----------------

* Tolerance 5HX

Metric

EDP	M	P	L	l	l1	d	a	Z	Type	DIN	Price
*48139111	1	0,25	40	-	5	2,5	2,1	2	1	DIN371	
*48139112	1,1	0,25	40	-	5	2,5	2,1	2	1	DIN371	
*48139113	1,2	0,25	40	-	5	2,5	2,1	2	1	DIN371	
*48139115	1,4	0,3	40	-	6	2,5	2,1	2	1	DIN371	
48139118	1,6	0,35	40	-	7	2,5	2,1	2	1	DIN371	
48139119	1,7	0,35	40	-	8	2,5	2,1	2	1	DIN371	
48139120	1,8	0,35	40	-	8	2,5	2,1	2	1	DIN371	
48139125	2	0,4	45	3,2	10	2,8	2,1	2	2	DIN371	
48139127	2,2	0,45	45	3,6	11	2,8	2,1	2	2	DIN371	
48139128	2,3	0,4	45	3,6	12	2,8	2,1	2	2	DIN371	
48139133	2,5	0,45	50	3,6	13	2,8	2,1	2	2	DIN371	
48139136	2,6	0,45	50	3,6	13	2,8	2,1	2	2	DIN371	
48139138	3	0,5	56	4	18	3,5	2,7	3	2	DIN371	
48139142	3,5	0,6	56	4,8	20	4	3	3	2	DIN371	
48139144	4	0,7	63	5,6	21	4,5	3,4	3	2	DIN371	
48139147	4,5	0,75	70	6	25	6	4,9	3	2	DIN371	
48139149	5	0,8	70	6,4	25	6	4,9	3	2	DIN371	
48139152	5,5	0,9	80	7,2	30	6	4,9	3	2	DIN371	
48139155	6	1	80	8	30	6	4,9	3	2	DIN371	
48139158	7	1	80	8	30	7	5,5	3	2	DIN371	
48139161	8	1,25	90	10	35	8	6,2	3	2	DIN371	
48139165	9	1,25	90	10	35	9	7	3	2	DIN371	
48139169	10	1,5	100	12	39	10	8	3	2	DIN371	
48139139	3	0,5	56	4	-	2,2	-	3	3	DIN376	
48139185	4	0,7	63	5,6	-	2,8	2,1	3	3	DIN376	
48139150	5	0,8	70	6,4	-	3,5	2,7	3	3	DIN376	
48139187	6	1	80	8	-	4,5	3,4	3	3	DIN376	
48139159	7	1	80	8	-	5,5	4,3	3	3	DIN376	
48139188	8	1,25	90	10	-	6	4,9	3	3	DIN376	
48139166	9	1,25	90	10	-	7	5,5	3	3	DIN376	
48139189	10	1,5	100	12	-	7	5,5	3	3	DIN376	
48139175	11	1,5	100	12	-	8	6,2	3	3	DIN376	
48139179	12	1,75	110	14	-	9	7	3	3	DIN376	
48139191	14	2	110	16	-	11	9	3	3	DIN376	
48139202	16	2	110	16	-	12	9	3	3	DIN376	
48139214	18	2,5	125	25	-	14	11	4	3	DIN376	
48139228	20	2,5	140	25	-	16	12	4	3	DIN376	
48139238	22	2,5	140	25	-	18	14,5	4	3	DIN376	
48139247	24	3	160	30	-	18	14,5	4	3	DIN376	

A-OIL-SFT

Threading | Cutting taps | Metric

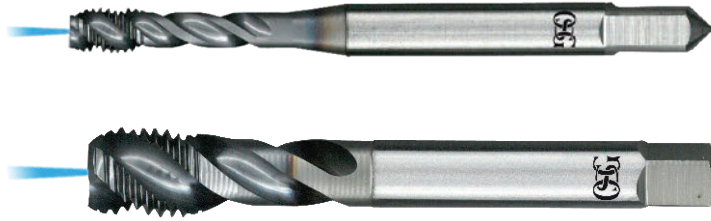

Type 1

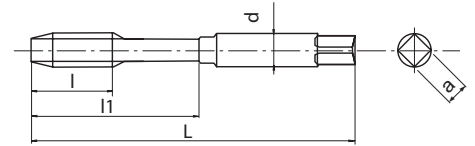

Type 2

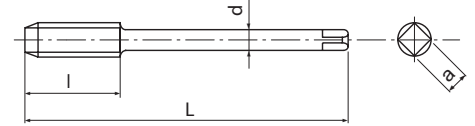

- First choice in quality and performance
- Powder metal spiral-fluted cutting tap for blind holes
- Multilayer TiCN coating
- High speed tapping in general steels, aluminium, stainless steels
- Centre through coolant

P	P	P	P	M	N	N	S	H	
C < 0,2%	0,25 < C < 0,4	C > 0,45%	SCM	INOX	Al	AC,ADC	Ti	25-35 HRC	
15-60	15-60	10-60	8-30	8-20	15-35	15-35	5-10	8-20	m/min

A	M	PM	V	45°	ISO 2 6HX	C/2,5			DIN 371	DIN 376
----------	----------	-----------	----------	------------	------------------	--------------	--	--	----------------	----------------

EDP	M	P	L	l	l1	d	a	Z	Type	DIN	Price
48140155	6	1	80	8	30	6	4,9	3	1	DIN371	
48140161	8	1,25	90	10	35	8	6,2	3	1	DIN371	
48140169	10	1,5	100	12	39	10	8	3	1	DIN371	
48140179	12	1,75	110	14	-	9	7	3	2	DIN376	
48140191	14	2	110	16	-	11	9	3	2	DIN376	
48140202	16	2	110	16	-	12	9	3	2	DIN376	
48140214	18	2,5	125	25	-	14	11	4	2	DIN376	
48140228	20	2,5	140	25	-	16	12	4	2	DIN376	
48140238	22	2,5	140	25	-	18	14,5	4	2	DIN376	
48140247	24	3	160	30	-	18	14,5	4	2	DIN376	
48140262	27	3	160	36	-	20	16	4	2	DIN376	
48140271	30	3,5	180	42	-	22	18	4	2	DIN376	
48140281	33	3,5	180	42	-	25	20	4	2	DIN376	
48140294	36	4	200	48	-	28	22	4	2	DIN376	
48140304	39	4	200	48	-	32	24	4	2	DIN376	
48140314	42	4,5	200	54	-	32	24	4	2	DIN376	
48140319	45	4,5	220	54	-	36	29	4	2	DIN376	
48140325	48	5	250	60	-	36	29	4	2	DIN376	
48140337	52	5	250	60	-	40	32	4	2	DIN376	
48140347	56	5,5	250	66	-	40	32	4	2	DIN376	

Threading | Cutting taps

Metric

A-SFT 6GX

Threading | Cutting taps | Metric

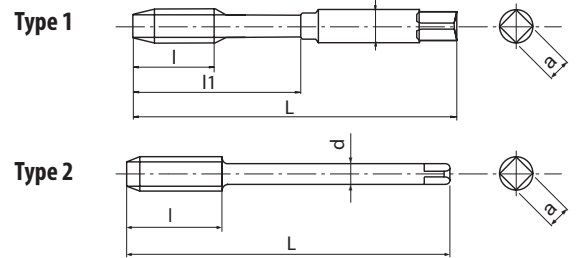

- First choice in quality and performance
- Powder metal spiral-fluted cutting tap for blind holes
- Multilayer TiCN coating
- High speed tapping in general steels, aluminium, stainless steels
- For 6G internal thread tolerance

Threading | Cutting taps

P C < 0,2%	P 0,25 < C < 0,4	P C > 0,45%	P SCM	M INOX	N Al	N AC, ADC	S Ti	H 25-35 HRC			m/min
15-60	15-60	10-60	8-30	8-20	15-35	15-35	5-10	8-20			

A	M	PM	V	45°	ISO 3 6GX	C/2,5		DIN 371	DIN 376
----------	----------	-----------	----------	------------	------------------	--------------	--	----------------	----------------

EDP	M	P	oversize	L	l	l1	d	a	Z	Type	DIN	Price
48201125	2	0,4	+0,019	45	3,2	10	2,8	2,1	2	1	DIN371	
48201133	2,5	0,45	+0,020	50	3,6	13	2,8	2,1	2	1	DIN371	
48201138	3	0,5	+0,020	56	4	18	3,5	2,7	3	1	DIN371	
48201144	4	0,7	+0,022	63	5,6	21	4,5	3,4	3	1	DIN371	
48201149	5	0,8	+0,024	70	6,4	25	6	4,9	3	1	DIN371	
48201155	6	1	+0,026	80	8	30	6	4,9	3	1	DIN371	
48201161	8	1,25	+0,028	90	10	35	8	6,2	3	1	DIN371	
48201169	10	1,5	+0,032	100	12	39	10	8	3	1	DIN371	
48201179	12	1,75	+0,034	110	14	-	9	7	3	2	DIN376	
48201202	16	2	+0,038	110	16	-	12	9	3	2	DIN376	

Metric

A-SFT 7GX

Threading | Cutting taps | Metric



Type 1

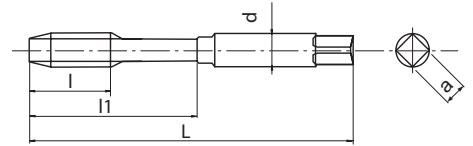

Type 2

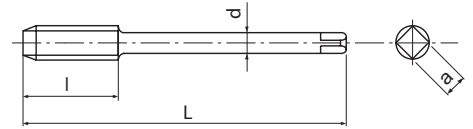

- First choice in quality and performance
- Powder metal spiral-fluted cutting tap for blind holes
- Multilayer TiCN coating
- High speed tapping in general steels, aluminium, stainless steels
- For 7G internal thread tolerance

P	P	P	P	M	N	N	S	H	
C < 0,2%	0,25 < C < 0,4	C > 0,45%	SCM	INOX	Al	AC,ADC	Ti	25-35 HRC	
15-60	15-60	10-60	8-30	8-20	15-35	15-35	5-10	8-20	m/min

A	M	PM	V	45°	7GX	C/2,5		DIN 371	DIN 376
----------	----------	-----------	----------	------------	------------	--------------	--	----------------	----------------

EDP	M	P	oversize	L	l	l1	d	a	Z	Type	DIN	Price
48202125	2	0,4	+0,038	45	3,2	10	2,8	2,1	2	1	DIN371	
48202133	2,5	0,45	+0,040	50	3,6	13	2,8	2,1	2	1	DIN371	
48202138	3	0,5	+0,040	56	4	18	3,5	2,7	3	1	DIN371	
48202144	4	0,7	+0,044	63	5,6	21	4,5	3,4	3	1	DIN371	
48202149	5	0,8	+0,048	70	6,4	25	6	4,9	3	1	DIN371	
48202155	6	1	+0,052	80	8	30	6	4,9	3	1	DIN371	
48202161	8	1,25	+0,056	90	10	35	8	6,2	3	1	DIN371	
48202169	10	1,5	+0,064	100	12	39	10	8	3	1	DIN371	
48202179	12	1,75	+0,068	110	14	-	9	7	3	2	DIN376	
48202202	16	2	+0,076	110	16	-	12	9	3	2	DIN376	

Threading | Cutting taps



Metric

A-SFT FORM E

Threading | Cutting taps | Metric



Type 1

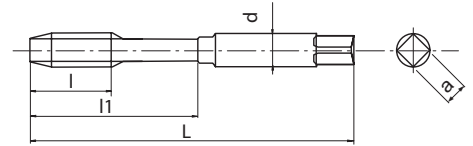

Type 2

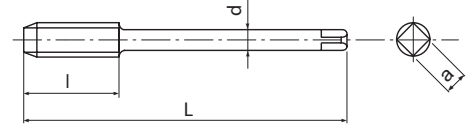

- First choice in quality and performance
- Powder metal spiral-fluted cutting tap for blind holes
- Multilayer TiCN coating
- High speed tapping in general steels, aluminium, stainless steels
- Form E chamfer

P	P	P	P	M	N	N	S	H	
C < 0,2%	0,25 < C < 0,4	C > 0,45%	SCM	INOX	Al	AC,ADC	Ti	25-35 HRC	m/min
15-60	15-60	10-60	8-30	8-20	15-35	15-35	5-10	8-20	

A	M	PM	V	45°	ISO 2 6HX	E/1,5	DIN 371	DIN 376
----------	----------	-----------	----------	------------	------------------	--------------	----------------	----------------

EDP	M	P	L	l	l1	d	a	Z	Type	DIN	Price
48203138	3	0,5	56	4	18	3,5	2,7	3	1	DIN371	
48203144	4	0,7	63	5,6	21	4,5	3,4	3	1	DIN371	
48203149	5	0,8	70	6,4	25	6	4,9	3	1	DIN371	
48203155	6	1	80	8	30	6	4,9	3	1	DIN371	
48203161	8	1,25	90	10	35	8	6,2	3	1	DIN371	
48203169	10	1,5	100	12	39	10	8	3	1	DIN371	
48203179	12	1,75	110	14	-	9	7	3	2	DIN376	
48203191	14	2	110	16	-	11	9	3	2	DIN376	
48203202	16	2	110	16	-	12	9	3	2	DIN376	

Threading | Cutting taps

Metric

A-SFT+0.1

Threading | Cutting taps | Metric

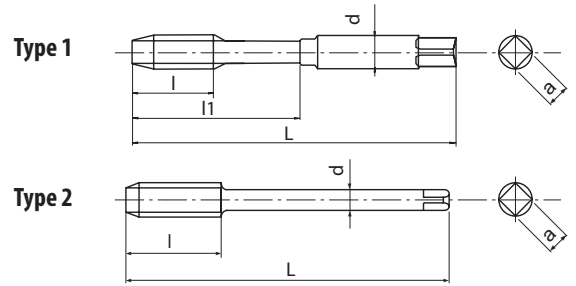

- First choice in quality and performance
- Powder metal spiral-fluted cutting tap for blind holes
- Multilayer TiCN coating
- High speed tapping in general steels, aluminium, stainless steels
- Oversized tap for 6H +0,1mm thread tolerance

P	P	P	P	M	N	N	S	H	
C < 0,2%	0,25 < C < 0,4	C > 0,45%	SCM	INOX	Al	AC,ADC	Ti	25-35 HRC	
15-60	15-60	10-60	8-30	8-20	15-35	15-35	5-10	8-20	m/min

A	M	PM	V	45°	6H +0.1	C/2,5		DIN 371	DIN 376
----------	----------	-----------	----------	------------	----------------	--------------	--	----------------	----------------

EDP	M	P	L	l	l1	d	a	Z	Type	DIN	Price
48204138	3	0,5	56	4	18	3,5	2,7	3	1	DIN371	
48204144	4	0,7	63	5,6	21	4,5	3,4	3	1	DIN371	
48204149	5	0,8	70	6,4	25	6	4,9	3	1	DIN371	
48204155	6	1	80	8	30	6	4,9	3	1	DIN371	
48204161	8	1,25	90	10	35	8	6,2	3	1	DIN371	
48204169	10	1,5	100	12	39	10	8	3	1	DIN371	
48204179	12	1,75	110	14	-	9	7	3	2	DIN376	
48204202	16	2	110	16	-	12	9	3	2	DIN376	

Threading | Cutting taps



Metric

A-LT-SFT

Threading | Cutting taps | Metric



Type 1

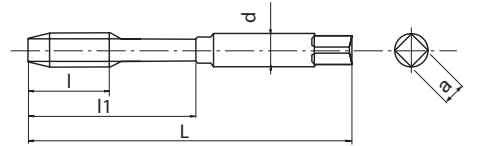

Type 2

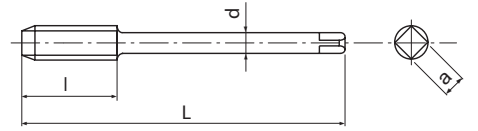

- First choice in quality and performance
- Powder metal spiral-fluted cutting tap for blind holes
- Multilayer TiCN coating
- High speed tapping in general steels, aluminium, stainless steels
- With long shank for long reach threading

Threading | Cutting taps

P C < 0,2%	P 0,25 < C < 0,4	P C > 0,45%	P SCM	M INOX	N Al	N AC,ADC	S Ti	H 25-35 HRC	
15-25	15-25	10-25	8-20	8-20	15-35	15-35	5-10	8-20	m/min



Metric

EDP	M	P	L	l	l1	d	a	Z	Type	Price
48208125	2	0,4	80	3,2	10	2,8	2,1	2	1	
48208133	2,5	0,45	100	3,6	13	2,8	2,1	2	1	
48208138	3	0,5	100	4	18	3,5	2,7	3	1	
48208144	4	0,7	125	5,6	21	4,5	3,4	3	1	
48208149	5	0,8	160	6,4	25	6	4,9	3	1	
48208155	6	1	160	8	30	6	4,9	3	1	
48208161	8	1,25	180	10	35	8	6,2	3	1	
48208169	10	1,5	200	12	39	10	8	3	1	
48209155	6	1	160	10	-	4,5	3,4	3	2	
48209161	8	1,25	180	11	-	6	4,9	3	2	
48209169	10	1,5	200	14	-	7	5,5	3	2	
48209179	12	1,75	200	14	-	9	7	3	2	
48209191	14	2	200	16	-	11	9	3	2	
48209202	16	2	200	16	-	12	9	3	2	
48209214	18	2,5	200	25	-	14	11	4	2	
48209228	20	2,5	200	25	-	16	12	4	2	

A-SFT-LH

Threading | Cutting taps | Metric

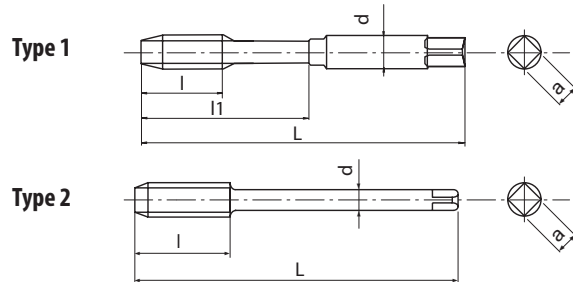

- First choice in quality and performance
- Powder metal spiral-fluted cutting tap for blind holes
- Multilayer TiCN coating
- High speed tapping in general steels, aluminium, stainless steels
- For left-hand threads

P C < 0,2%	P 0,25 < C < 0,4	P C > 0,45%	P SCM	M INOX	N Al	N AC,ADC	S Ti	H 25-35 HRC	
15-60	15-60	10-60	8-30	8-20	15-35	15-35	5-10	8-20	m/min

A	M	PM	V	45°	ISO 2 6HX	C/2,5	DIN 371	DIN 376	LH
----------	----------	-----------	----------	------------	------------------	--------------	----------------	----------------	-----------

EDP	M	P	L	l	l1	d	a	Z	Type	DIN	Price
48217138	3	0,5	56	4	18	3,5	2,7	3	1	DIN371	
48217144	4	0,7	63	5,6	21	4,5	3,4	3	1	DIN371	
48217149	5	0,8	70	6,4	25	6	4,9	3	1	DIN371	
48217155	6	1	80	8	30	6	4,9	3	1	DIN371	
48217161	8	1,25	90	10	35	8	6,2	3	1	DIN371	
48217169	10	1,5	100	12	39	10	8	3	1	DIN371	
48217179	12	1,75	110	14	-	9	7	3	2	DIN376	
48217191	14	2	110	16	-	11	9	3	2	DIN376	
48217202	16	2	110	16	-	12	9	3	2	DIN376	
48217214	18	2,5	125	25	-	14	11	4	2	DIN376	
48217228	20	2,5	140	25	-	16	12	4	2	DIN376	
48217238	22	2,5	140	25	-	18	14,5	4	2	DIN376	
48217247	24	3	160	30	-	18	14,5	4	2	DIN376	

Threading | Cutting taps



Metric

A-SFT-HB Weldon

Threading | Cutting taps | Metric

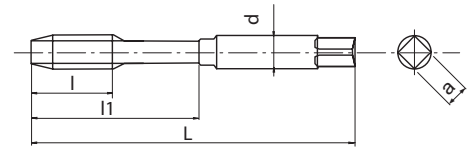

- First choice in quality and performance
- Powder metal spiral-fluted cutting tap for blind holes
- Multilayer TiCN coating
- High speed tapping in general steels, aluminium, stainless steels
- With Weldon shank

Threading | Cutting taps

P $C < 0,2\%$	P $0,25 < C < 0,4$	P $C > 0,45\%$	P SCM	M INOX	N Al	N AC,ADC	S Ti	H 25-35 HRC		m/min
15-60	15-60	10-60	8-30	8-20	15-35	15-35	5-10	8-20		

A	M	PM	V	45°	ISO 2 6HX	C/2,5	DIN 371	DIN 1835	HB
----------	----------	-----------	----------	------------	------------------	--------------	----------------	-----------------	-----------

EDP	M	P	L	l	l1	d	a	Z	DIN	Price
48220138	3	0,5	56	4	18	6	4,9	3	DIN371/1835	
48220144	4	0,7	63	5,6	21	6	4,9	3	DIN371/1835	
48220149	5	0,8	70	6,4	25	6	4,9	3	DIN371/1835	
48220155	6	1	80	8	30	6	4,9	3	DIN371/1835	
48220161	8	1,25	90	10	35	8	6,2	3	DIN371/1835	
48220169	10	1,5	100	12	39	10	8	3	DIN371/1835	
48220179	12	1,75	110	14	46	12	9	3	DIN371/1835	
48220191	14	2	110	16	49	14	11	3	DIN371/1835	
48220202	16	2	110	16	56	16	12	3	DIN371/1835	



Metric

A-SFT

Threading | Cutting taps | Metric Fine

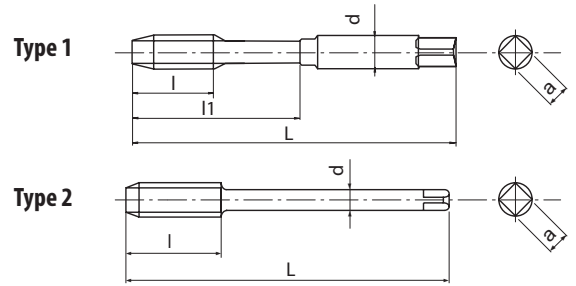

- First choice in quality and performance
- Powder metal spiral-fluted cutting tap for blind holes
- Multilayer TiCN coating
- High speed tapping in general steels, aluminium, stainless steels

P C < 0,2%	P 0,25 < C < 0,4	P C > 0,45%	P SCM	M INOX	N Al	N AC,ADC	S Ti	H 25-35 HRC		m/min
15-60	15-60	10-60	8-30	8-20	15-35	15-35	5-10	8-20		

A	MF	PM	V	45°	ISO 2 6HX	C/2,5	DIN 371	DIN 374
----------	-----------	-----------	----------	------------	------------------	--------------	----------------	----------------

EDP	MF	P	L	l	l1	d	a	Z	Type	DIN	Price
48139135	2,5	0,35	50	3,6	13	2,8	2,1	2	1	DIN371	
48139137	2,6	0,35	50	3,6	13	2,8	2,1	2	1	DIN371	
48139141	3	0,35	56	4	18	3,5	2,7	3	1	DIN371	
48139143	3,5	0,35	56	4,8	20	4	3	3	1	DIN371	
48139145	4	0,5	63	5,6	21	4,5	3,4	3	1	DIN371	
48139146	4	0,35	63	5,6	21	4,5	3,4	3	1	DIN371	
48139148	4,5	0,5	70	6	25	6	4,9	3	1	DIN371	
48139151	5	0,5	70	6,4	25	6	4,9	3	1	DIN371	
48139601	6	0,75	80	8	30	6	4,9	3	1	DIN371	
48139602	6	0,5	80	8	30	6	4,9	3	1	DIN371	
48139160	7	0,75	80	8	30	7	5,5	3	1	DIN371	
48139603	8	1	90	10	35	8	6,2	3	1	DIN371	
48139604	8	0,75	80	10	35	8	6,2	3	1	DIN371	
48139605	9	1	90	10	35	9	7	3	1	DIN371	
48139606	10	1,25	100	12	39	10	8	3	1	DIN371	
48139607	10	1	90	12	35	10	8	3	1	DIN371	
48139608	10	0,75	90	12	35	10	8	3	1	DIN371	
48139156	6	0,75	80	8	-	4,5	3,4	3	2	DIN374	
48139157	6	0,5	80	8	-	4,5	3,4	3	2	DIN374	
48139162	8	1	90	10	-	6	4,9	3	2	DIN374	
48139163	8	0,75	80	8	-	6	4,9	3	2	DIN374	
48139167	9	1	90	10	-	7	5,5	3	2	DIN374	
48139170	10	1,25	100	12	-	7	5,5	3	2	DIN374	
48139171	10	1	90	10	-	7	5,5	3	2	DIN374	
48139172	10	0,75	90	10	-	7	5,5	3	2	DIN374	
48139176	11	1	90	12	-	8	6,2	3	2	DIN374	
48139180	12	1,5	100	14	-	9	7	3	2	DIN374	
48139181	12	1,25	100	12	-	9	7	3	2	DIN374	
48139182	12	1	100	12	-	9	7	3	2	DIN374	
48139192	14	1,5	100	16	-	11	9	3	2	DIN374	
48139193	14	1,25	100	16	-	11	9	3	2	DIN374	
48139194	14	1	100	16	-	11	9	3	2	DIN374	
48139203	16	1,5	100	16	-	12	9	3	2	DIN374	
48139204	16	1	100	16	-	12	9	3	2	DIN374	
48139216	18	1,5	110	16	-	14	11	4	2	DIN374	
48139218	18	1	110	16	-	14	11	4	2	DIN374	
48139220	20	2	140	25	-	16	12	4	2	DIN374	
48139230	20	1,5	125	16	-	16	12	4	2	DIN374	
48139232	20	1	125	16	-	16	12	4	2	DIN374	
48139239	22	2	140	25	-	18	14,5	4	2	DIN374	
48139240	22	1,5	125	16	-	18	14,5	4	2	DIN374	
48139241	22	1	125	16	-	18	14,5	4	2	DIN374	
48139249	24	2	140	30	-	18	14,5	4	2	DIN374	
48139250	24	1,5	140	16	-	18	14,5	4	2	DIN374	
48139251	24	1	140	16	-	18	14,5	4	2	DIN374	



A-SFT 6GX

Threading | Cutting taps | Metric Fine

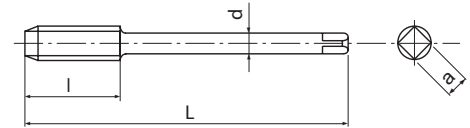

- First choice in quality and performance
- Powder metal spiral-fluted cutting tap for blind holes
- Multilayer TiCN coating
- High speed tapping in general steels, aluminium, stainless steels
- For 6G internal thread tolerance

P	P	P	P	M	N	N	S	H	m/min	
C < 0,2%	0,25 < C < 0,4	C > 0,45%	SCM	INOX	Al	AC,ADC	Ti	25-35 HRC		
15-60	15-60	10-60	8-30	8-20	15-35	15-35	5-10	8-20		

A	MF	PM	V	45°	ISO 3 6GX	C/2,5		DIN 374
----------	-----------	-----------	----------	------------	------------------	--------------	--	----------------

EDP	MF	P	oversize	L	l	d	a	Z	DIN	Price
48201156	6	0,75	+0,022	80	8	4,5	3,4	3	DIN374	
48201162	8	1	+0,026	90	10	6	4,9	3	DIN374	
48201163	8	0,75	+0,022	80	8	6	4,9	3	DIN374	
48201170	10	1,25	+0,028	100	12	7	5,5	3	DIN374	
48201171	10	1	+0,026	90	10	7	5,5	3	DIN374	
48201180	12	1,5	+0,032	100	14	9	7	3	DIN374	
48201181	12	1,25	+0,028	100	12	9	7	3	DIN374	
48201182	12	1	+0,026	100	12	9	7	3	DIN374	
48201192	14	1,5	+0,032	100	16	11	9	3	DIN374	
48201203	16	1,5	+0,032	100	16	12	9	3	DIN374	
48201216	18	1,5	+0,032	110	16	14	11	4	DIN374	
48201230	20	1,5	+0,032	125	16	16	12	4	DIN374	
48201240	22	1,5	+0,032	125	16	18	14,5	4	DIN374	
48201250	24	1,5	+0,032	140	16	18	14,5	4	DIN374	

Threading | Cutting taps

Metric Fine



A-SFT

Threading | Cutting taps | UNC

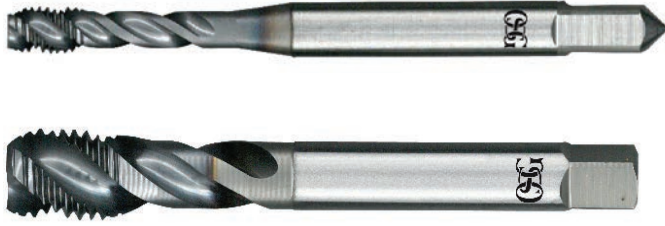

Type 1

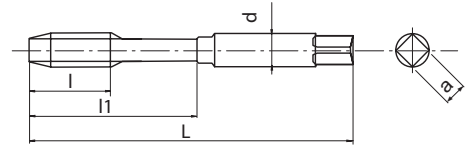

Type 2

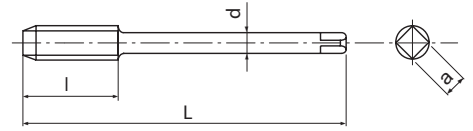

- First choice in quality and performance
- Powder metal spiral-fluted cutting tap for blind holes
- Multilayer TiCN coating
- High speed tapping in general steels, aluminium, stainless steels

Threading | Cutting taps



UNC

P C < 0,2%	P 0,25 < C < 0,4	P C > 0,45%	P SCM	M INOX	N Al	N AC,ADC	S Ti	H 25-35 HRC	m/min
15-60	15-60	10-60	8-30	8-20	15-35	15-35	5-10	8-20	

A	UNC	PM	V	45°	ANSI 2BX	C/2,5	DIN 2184-1	DIN 2184-1
----------	------------	-----------	----------	------------	-----------------	--------------	-------------------	-------------------

EDP	UNC	P	L	l	l1	d	a	Z	Type	DIN	Price
48139453	2	56	45	3,6	11	2,8	2,1	2	1	DIN2184-1	
48139455	3	48	50	3,6	13	2,8	2,1	2	1	DIN2184-1	
48139457	4	40	56	5,1	18	3,5	2,7	2	1	DIN2184-1	
48139459	5	40	56	5,1	18	3,5	2,7	2	1	DIN2184-1	
48139461	6	32	56	6,4	20	4	3	2	1	DIN2184-1	
48139464	8	32	63	6,4	21	4,5	3,4	2	1	DIN2184-1	
48139466	10	24	70	8,5	25	6	4,9	2	1	DIN2184-1	
48139468	12	24	80	8,5	30	6	4,9	2	1	DIN2184-1	
48139471	1/4	20	80	10,2	30	7	5,5	2	1	DIN2184-1	
48139474	5/16	18	90	11,3	35	8	6,2	3	1	DIN2184-1	
48139479	3/8	16	100	12,7	39	10	8	3	1	DIN2184-1	
48139484	7/16	14	100	14,5	-	8	6,2	3	2	DIN2184-1	
48139489	1/2	13	110	15,6	-	9	7	3	2	DIN2184-1	
48139494	9/16	12	110	16,9	-	11	9	3	2	DIN2184-1	
48139501	5/8	11	110	18,5	-	12	9	3	2	DIN2184-1	
48139515	3/4	10	125	25,4	-	14	11	4	2	DIN2184-1	
48139526	7/8	9	140	28,2	-	18	14,5	4	2	DIN2184-1	
48139538	1	8	160	31,8	-	18	14,5	4	2	DIN2184-1	

A-SFT

Threading | Cutting taps | UNF



Type 1

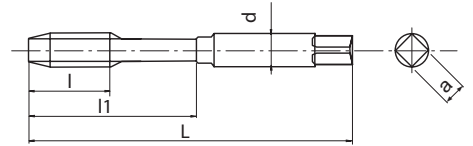

Type 2

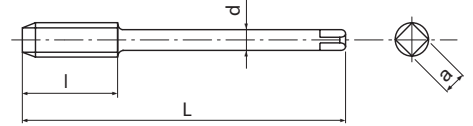

- First choice in quality and performance
- Powder metal spiral-fluted cutting tap for blind holes
- Multilayer TiCN coating
- High speed tapping in general steels, aluminium, stainless steels

P C < 0,2%	P 0,25 < C < 0,4	P C > 0,45%	P SCM	M INOX	N Al	N AC,ADC	S Ti	H 25-35 HRC	
15-60	15-60	10-60	8-30	8-20	15-35	15-35	5-10	8-20	m/min

A	UNF	PM	V	45°	ANSI 2BX	C/2,5	DIN 2184-1	DIN 2184-1
----------	------------	-----------	----------	------------	-----------------	--------------	-------------------	-------------------

EDP	UNF	P	L	l	l1	d	a	Z	Type	DIN	Price
48139454	2	64	45	3,6	11	2,8	2,1	2	1	DIN2184-1	
48139456	3	56	50	3,6	13	2,8	2,1	2	1	DIN2184-1	
48139458	4	48	56	5,1	18	3,5	2,7	2	1	DIN2184-1	
48139460	5	44	56	5,1	18	3,5	2,7	2	1	DIN2184-1	
48139462	6	40	56	6,4	20	4	3	2	1	DIN2184-1	
48139465	8	36	63	6,4	21	4,5	3,4	2	1	DIN2184-1	
48139467	10	32	70	8,5	25	6	4,9	2	1	DIN2184-1	
48139469	12	28	80	8,5	30	6	4,9	2	1	DIN2184-1	
48139472	1/4	28	80	10,2	30	7	5,5	2	1	DIN2184-1	
48139476	5/16	24	90	11,3	35	8	6,2	3	1	DIN2184-1	
48139481	3/8	24	90	12,7	35	10	8	3	1	DIN2184-1	
48139486	7/16	20	100	14,5	-	8	6,2	3	2	DIN2184-1	
48139491	1/2	20	100	15,6	-	9	7	3	2	DIN2184-1	
48139496	9/16	18	100	16,9	-	11	9	3	2	DIN2184-1	
48139504	5/8	18	100	18,5	-	12	9	3	2	DIN2184-1	
48139517	3/4	16	110	25,4	-	14	11	4	2	DIN2184-1	
48139528	7/8	14	125	28,2	-	18	14,5	4	2	DIN2184-1	
48139539	1	12	140	31,8	-	18	14,5	4	2	DIN2184-1	



A-SFT

Threading | Cutting taps | G (BSP)

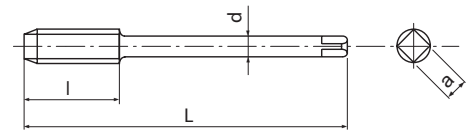

- First choice in quality and performance
- Powder metal spiral-fluted cutting tap for blind holes
- Multilayer TiCN coating
- High speed tapping in general steels, aluminium, stainless steels

Threading | Cutting taps

P ● C < 0,2%	P ● 0,25 < C < 0,4	P ● C > 0,45%	P ● SCM	M ● INOX	N ○ Al	N ○ AC,ADC	S ○ Ti	H ○ 25-35 HRC	m/min
15-60	15-60	10-60	8-30	8-20	15-35	15-35	5-10	8-20	

A
G
PM
V
45°
C/2,5
DIN 5156

EDP	G	P	L	l	d	a	Z	DIN	Price
48139900	1/8	28	90	20	7	5,5	3	DIN5156	
48139000	1/4	19	100	22	11	9	3	DIN5156	
48139100	3/8	19	100	22	12	9	4	DIN5156	
48139200	1/2	14	125	25	16	12	4	DIN5156	
48139300	5/8	14	125	25	18	14,5	4	DIN5156	
48139400	3/4	14	140	28	20	16	4	DIN5156	
48139500	7/8	14	150	28	22	18	4	DIN5156	
48139600	1	11	160	30	25	20	4	DIN5156	

A-SFT

Threading | Cutting taps | BSF

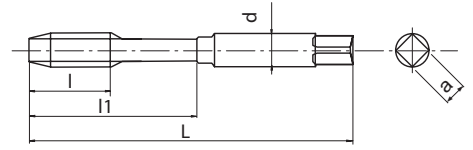

- First choice in quality and performance
- Powder metal spiral-fluted cutting tap for blind holes
- Multilayer TiCN coating
- High speed tapping in general steels, aluminium, stainless steels

Threading | Cutting taps

P C < 0,2%	P 0,25 < C < 0,4	P C > 0,45%	P SCM	M INOX	N Al	N AC,ADC	S Ti	H 25-35 HRC	m/min
15-60	15-60	10-60	8-30	8-20	15-35	15-35	5-10	8-20	

A	BSF	PM	V	MED	C/2,5	DIN 2184-1
----------	------------	-----------	----------	------------	--------------	-------------------



BSF

EDP	BSF	TPI	L	l	l1	d	a	Z	DIN	Price
48139731	1/4	26	80	17	30	7	5,5	3	DIN2184-1	
48139732	5/16	22	90	17	35	8	6,2	3	DIN2184-1	
48139733	3/8	20	100	18	39	10	8	3	DIN2184-1	
48139734	7/16	18	100	22	-	8	6,2	3	DIN2184-1	
48139735	1/2	16	100	22	-	9	7	3	DIN2184-1	
48139737	5/8	14	110	27	-	12	9	3	DIN2184-1	
48139739	3/4	12	125	27	-	14	11	3	DIN2184-1	
48139742	1	10	160	36	-	18	14,5	3	DIN2184-1	

A-SFT

Threading | Cutting taps | BA

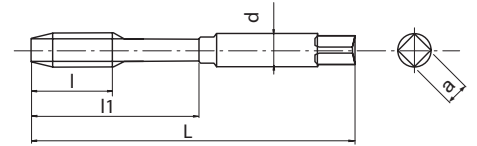

- First choice in quality and performance
- Powder metal spiral-fluted cutting tap for blind holes
- Multilayer TiCN coating
- High speed tapping in general steels, aluminium, stainless steels

P C < 0,2%	P 0,25 < C < 0,4	P C > 0,45%	P SCM	M INOX	N Al	N AC, ADC	S Ti	H 25-35 HRC		m/min
15-60	15-60	10-60	8-30	8-20	15-35	15-35	5-10	8-20		

A
BA (BS93)
PM
V
C/2,5

EDP	BA	L	l	l1	d	a	Z	Price
48139910	0	66	19	30	6,3	5	3	
48139911	1	62	17	26	5,6	4,5	3	
48139912	2	58	16	25	5	4	3	
48139913	3	53	13	21	4,5	3,55	2	
48139914	4	50	13	20	3,55	2,8	2	
48139915	5	48	11	18	3,15	2,5	2	
48139916	6	44,5	9,5	-	2,8	2,24	2	
48139917	7	44,5	9,5	-	2,8	2,24	2	
48139918	8	44,5	9,5	-	2,8	2,24	2	
48139919	9	41	8	-	2,5	2	2	
48139920	10	41	8	-	2,5	2	2	
48139921	11	41	8	-	2,5	2	2	
48139922	12	40	7	-	2,5	2	2	



A-POT NEW SIZES

Threading | Cutting taps | Metric



Type 1

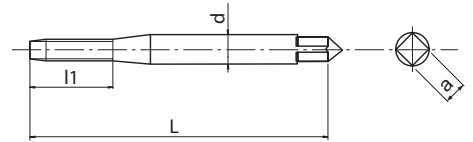

Type 2

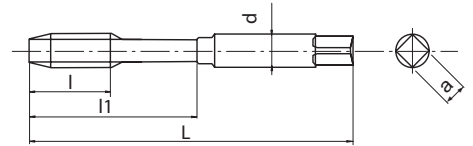

Type 3

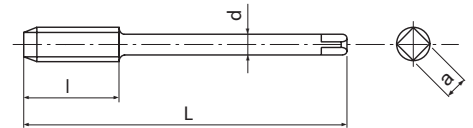

- First choice in quality and performance
- Powder metal spiral-point cutting tap for through holes
- Multilayer TiCN coating
- High speed tapping in general steels, aluminium, stainless steels

Threading | Cutting taps

P C < 0,2%	P 0,25 < C < 0,4	P C > 0,45%	P SCM	M INOX	N Al	N AC,ADC	S Ti	H 25-35 HRC	m/min
15-60	15-60	10-60	8-30	8-20	15-35	15-35	5-10	8-20	

A	M	PM	V	ISO 2 6HX	B/4	DIN 371	DIN 376
----------	----------	-----------	----------	------------------	------------	----------------	----------------

* Tolerance 5HX

Metric

EDP	M	P	L	l	l1	d	a	Z	Type	DIN	Price
*48145111 ^{NEW}	1	0,25	40	-	5	2,5	2,1	2	1	DIN371	
*48145112 ^{NEW}	1,1	0,25	40	-	5	2,5	2,1	2	1	DIN371	
*48145113 ^{NEW}	1,2	0,25	40	-	5	2,5	2,1	2	1	DIN371	
*48145115	1,4	0,3	40	-	7	2,5	2,1	2	1	DIN371	
48145118	1,6	0,35	40	-	8	2,5	2,1	2	1	DIN371	
48145119	1,7	0,35	40	-	8	2,5	2,1	2	1	DIN371	
48145120	1,8	0,35	40	-	8	2,5	2,1	2	1	DIN371	
48145125	2	0,4	45	-	8	2,8	2,1	2	1	DIN371	
48145127	2,2	0,45	45	-	9	2,8	2,1	2	1	DIN371	
48145128	2,3	0,4	45	-	9	2,8	2,1	2	1	DIN371	
48145133	2,5	0,45	50	-	9	2,8	2,1	2	1	DIN371	
48145136	2,6	0,45	50	-	9	2,8	2,1	2	1	DIN371	
48145138	3	0,5	56	11	18	3,5	2,7	3	2	DIN371	
48145142	3,5	0,6	56	12	20	4	3	3	2	DIN371	
48145144	4	0,7	63	13	21	4,5	3,4	3	2	DIN371	
48145147	4,5	0,75	70	16	25	6	4,9	3	2	DIN371	
48145149	5	0,8	70	16	25	6	4,9	3	2	DIN371	
48145152	5,5	0,9	80	17	30	6	4,9	3	2	DIN371	
48145155	6	1	80	19	30	6	4,9	3	2	DIN371	
48145158	7	1	80	19	30	7	5,5	3	2	DIN371	
48145161	8	1,25	90	22	35	8	6,2	3	2	DIN371	
48145165	9	1,25	90	22	35	9	7	3	2	DIN371	
48145169	10	1,5	100	24	39	10	8	3	2	DIN371	
48145139	3	0,5	56	11	-	2,2	-	3	3	DIN376	
48145185	4	0,7	63	13	-	2,8	2,1	3	3	DIN376	
48145150	5	0,8	70	16	-	3,5	2,7	3	3	DIN376	
48145187	6	1	80	19	-	4,5	3,4	3	3	DIN376	
48145159	7	1	80	19	-	5,5	4,3	3	3	DIN376	
48145188	8	1,25	90	22	-	6	4,9	3	3	DIN376	
48145166	9	1,25	90	22	-	7	5,5	3	3	DIN376	
48145189	10	1,5	100	24	-	7	5,5	3	3	DIN376	
48145175	11	1,5	100	24	-	8	6,2	3	3	DIN376	
48145179	12	1,75	110	28	-	9	7	3	3	DIN376	
48145191	14	2	110	30	-	11	9	3	3	DIN376	
48145202	16	2	110	32	-	12	9	3	3	DIN376	
48145214	18	2,5	125	34	-	14	11	3	3	DIN376	
48145228	20	2,5	140	34	-	16	12	3	3	DIN376	
48145238	22	2,5	140	34	-	18	14,5	3	3	DIN376	
48145247	24	3	160	38	-	18	14,5	3	3	DIN376	

A-OIL-POT

Threading | Cutting taps | Metric

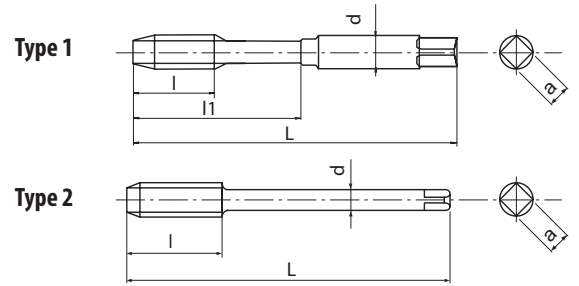

- First choice in quality and performance
- Powder metal spiral-point cutting tap for through holes
- Multilayer TiCN coating
- High speed tapping in general steels, aluminium, stainless steels
- Side through coolant

P C < 0,2%	P 0,25 < C < 0,4	P C > 0,45%	P SCM	M INOX	N Al	N AC, ADC	S Ti	H 25-35 HRC	
15-60	15-60	10-60	8-30	8-20	15-35	15-35	5-10	8-20	m/min

A	M	PM	V	ISO 2 6HX	B/4			DIN 371	DIN 376
----------	----------	-----------	----------	------------------	------------	--	--	----------------	----------------

EDP	M	P	L	l	l1	d	a	Z	Type	DIN	Price
48214155	6	1	80	19	30	6	4,9	3	1	DIN371	
48214161	8	1,25	90	22	35	8	6,2	3	1	DIN371	
48214169	10	1,5	100	24	39	10	8	3	1	DIN371	
48214179	12	1,75	110	28	-	9	7	3	2	DIN376	
48214191	14	2	110	30	-	11	9	3	2	DIN376	
48214202	16	2	110	32	-	12	9	3	2	DIN376	
48214214	18	2,5	125	34	-	14	11	3	2	DIN376	
48214228	20	2,5	140	34	-	16	12	3	2	DIN376	
48214238	22	2,5	140	34	-	18	14,5	3	2	DIN376	
48214247	24	3	160	38	-	18	14,5	3	2	DIN376	



A-POT 6GX

Threading | Cutting taps | Metric

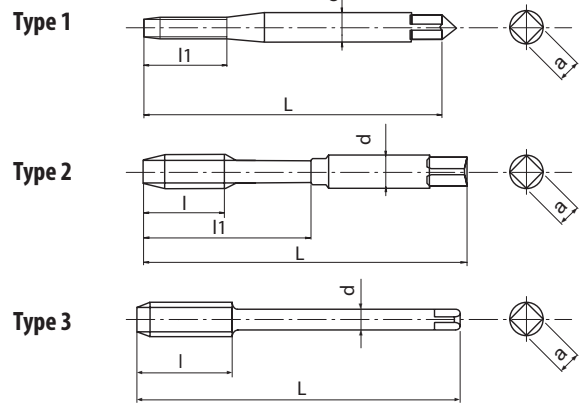
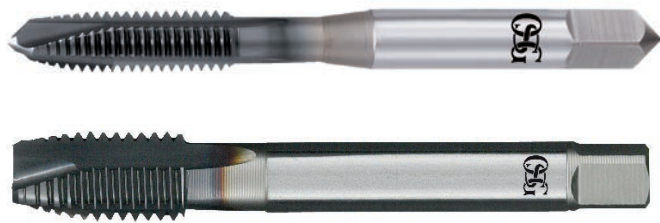

- First choice in quality and performance
- Powder metal spiral-point cutting tap for through holes
- Multilayer TiCN coating
- High speed tapping in general steels, aluminium, stainless steels
- For 6G internal thread tolerance

P C < 0,2%	P 0,25 < C < 0,4	P C > 0,45%	P SCM	M INOX	N Al	N AC,ADC	S Ti	H 25-35 HRC	
15-60	15-60	10-60	8-30	8-20	15-35	15-35	5-10	8-20	m/min

A	M	PM	V	ISO 3 6GX	B/4	DIN 371	DIN 376
----------	----------	-----------	----------	------------------	------------	----------------	----------------

EDP	M	P	oversize	L	l	l1	d	a	Z	Type	DIN	Price
48205125	2	0,4	+0,019	45	-	8	2,8	2,1	2	1	DIN371	
48205133	2,5	0,45	+0,020	50	-	9	2,8	2,1	2	1	DIN371	
48205138	3	0,5	+0,020	56	11	18	3,5	2,7	3	2	DIN371	
48205144	4	0,7	+0,022	63	13	21	4,5	3,4	3	2	DIN371	
48205149	5	0,8	+0,024	70	16	25	6	4,9	3	2	DIN371	
48205155	6	1	+0,026	80	19	30	6	4,9	3	2	DIN371	
48205161	8	1,25	+0,028	90	22	35	8	6,2	3	2	DIN371	
48205169	10	1,5	+0,032	100	24	39	10	8	3	2	DIN371	
48205179	12	1,75	+0,034	110	28	-	9	7	3	3	DIN376	
48205202	16	2	+0,038	110	32	-	12	9	3	3	DIN376	

Threading | Cutting taps

Metric

A-POT 7GX

Threading | Cutting taps | Metric

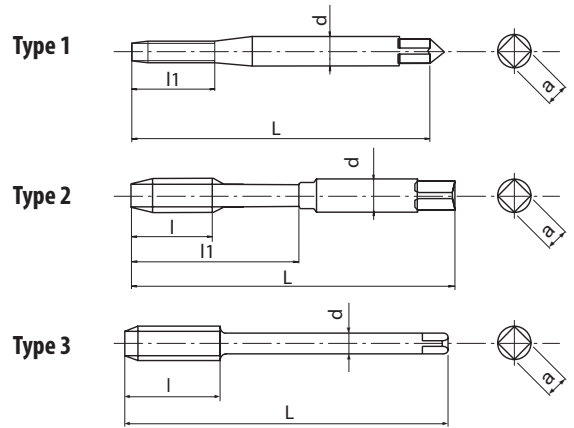
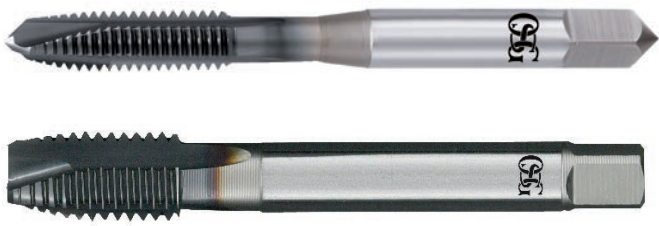

- First choice in quality and performance
- Powder metal spiral-point cutting tap for through holes
- Multilayer TiCN coating
- High speed tapping in general steels, aluminium, stainless steels
- For 7G internal thread tolerance

Material selection icons with speed ranges (m/min):

- P C < 0,2% → 15-60
- P 0,25 < C < 0,4 → 15-60
- P C > 0,45% → 10-60
- P SCM → 8-30
- M INOX → 8-20
- N Al → 15-35
- N AC/ADC → 15-35
- S Ti → 5-10
- H 25-35 HRC → 8-20

Product series and standards icons:

- A (Red)
- M
- PM
- V
- 7GX
- B/4
- DIN 371
- DIN 376

EDP	M	P	oversize	L	l	l1	d	a	Z	Type	DIN	Price
48206125	2	0,4	+0,038	45	-	8	2,8	2,1	2	1	DIN371	
48206133	2,5	0,45	+0,040	50	-	9	2,8	2,1	2	1	DIN371	
48206138	3	0,5	+0,040	56	11	18	3,5	2,7	3	2	DIN371	
48206144	4	0,7	+0,044	63	13	21	4,5	3,4	3	2	DIN371	
48206149	5	0,8	+0,048	70	16	25	6	4,9	3	2	DIN371	
48206155	6	1	+0,052	80	19	30	6	4,9	3	2	DIN371	
48206161	8	1,25	+0,056	90	22	35	8	6,2	3	2	DIN371	
48206169	10	1,5	+0,064	100	24	39	10	8	3	2	DIN371	
48206179	12	1,75	+0,068	110	14	-	28	7	3	3	DIN376	
48206202	16	2	+0,076	110	16	-	32	9	3	3	DIN376	



A-POT+0.1

Threading | Cutting taps | Metric

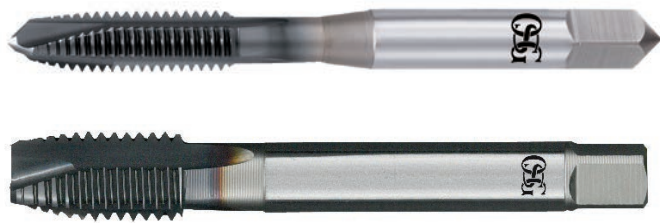

Type 1

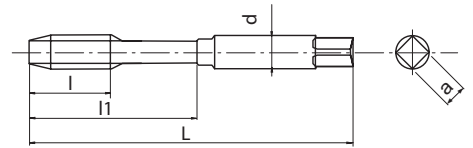

Type 2

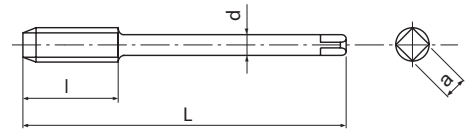

- First choice in quality and performance
- Powder metal spiral-point cutting tap for through holes
- Multilayer TiCN coating
- High speed tapping in general steels, aluminium, stainless steels
- Oversized tap for 6H +0,1mm thread tolerance

Threading | Cutting taps

P C < 0,2%	P 0,25 < C < 0,4	P C > 0,45%	P SCM	M INOX	N Al	N AC,ADC	S Ti	H 25-35 HRC	
15-60	15-60	10-60	8-30	8-20	15-35	15-35	5-10	8-20	m/min

A	M	PM	V	6H +0.1	B/4	DIN 371	DIN 376
----------	----------	-----------	----------	----------------	------------	----------------	----------------

EDP	M	P	L	l	l1	d	a	Z	Type	DIN	Price
48259138	3	0,5	56	11	18	3,5	2,7	3	1	DIN371	
48259144	4	0,7	63	13	21	4,5	3,4	3	1	DIN371	
48259149	5	0,8	70	16	25	6	4,9	3	1	DIN371	
48259155	6	1	80	19	30	6	4,9	3	1	DIN371	
48259161	8	1,25	90	22	35	8	6,2	3	1	DIN371	
48259169	10	1,5	100	24	39	10	8	3	1	DIN371	
48259179	12	1,75	110	28	-	9	7	3	2	DIN376	
48259202	16	2	110	32	-	12	9	3	2	DIN376	

Metric

A-LT-POT

Threading | Cutting taps | Metric



- First choice in quality and performance
- Powder metal spiral-point cutting tap for through holes
- Multilayer TiCN coating
- High speed tapping in general steels, aluminium, stainless steels
- With long shank for long reach threading

Type 1

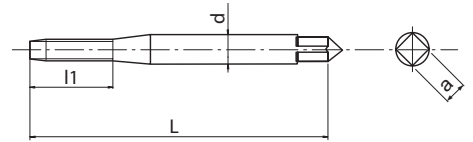

Type 2

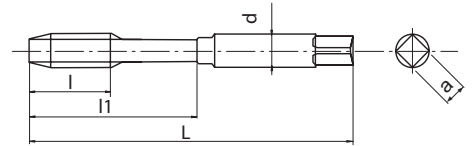

Type 3

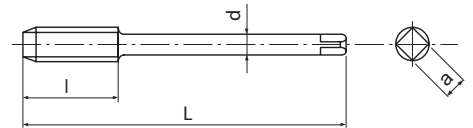

P C < 0,2%	P 0,25 < C < 0,4	P C > 0,45%	P SCM	M INOX	N Al	N AC,ADC	S Ti	H 25-35 HRC	m/min
15-60	15-60	10-60	8-30	8-20	15-35	15-35	5-10	8-20	

A	M	PM	V	ISO 2 6HX	B/4	DIN 371	DIN 376
----------	----------	-----------	----------	------------------	------------	----------------	----------------

EDP	M	P	L	l	l1	d	a	Z	Type	DIN	Price
48210125	2	0,4	80	8	-	2,8	2,1	2	1	DIN371	
48210133	2,5	0,45	100	9	-	2,8	2,1	2	1	DIN371	
48210138	3	0,5	100	11	18	3,5	2,7	3	2	DIN371	
48210144	4	0,7	125	13	21	4,5	3,4	3	2	DIN371	
48210149	5	0,8	160	16	25	6	4,9	3	2	DIN371	
48210155	6	1	160	19	30	6	4,9	3	2	DIN371	
48210161	8	1,25	180	22	35	8	6,2	3	2	DIN371	
48210169	10	1,5	200	24	39	10	8	3	2	DIN371	
48211155	6	1	160	19	-	4,5	3,4	3	3	DIN376	
48211161	8	1,25	180	22	-	6	4,9	3	3	DIN376	
48211169	10	1,5	200	24	-	7	5,5	3	3	DIN376	
48211179	12	1,75	200	28	-	9	7	3	3	DIN376	
48211191	14	2	200	30	-	11	9	3	3	DIN376	
48211202	16	2	200	32	-	12	9	3	3	DIN376	
48211214	18	2,5	200	34	-	14	11	3	3	DIN376	
48211228	20	2,5	200	34	-	16	12	3	3	DIN376	

A-POT-LH

Threading | Cutting taps | Metric



Type 1

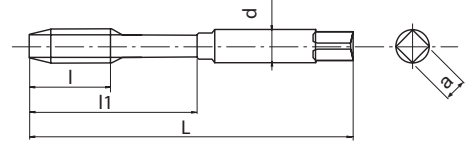

Type 2

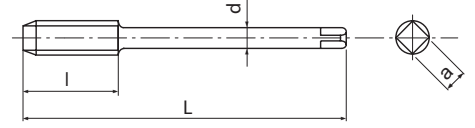

- First choice in quality and performance
- Powder metal spiral-point cutting tap for through holes
- Multilayer TiCN coating
- High speed tapping in general steels, aluminium, stainless steels
- For left-hand threads

Threading | Cutting taps

P C < 0,2%	P 0,25 < C < 0,4	P C > 0,45%	P SCM	M INOX	N Al	N AC,ADC	S Ti	H 25-35 HRC	
15-60	15-60	10-60	8-30	8-20	15-35	15-35	5-10	8-20	m/min

A	M	PM	V	ISO 2 6HX	B/4	DIN 371	DIN 376	LH
----------	----------	-----------	----------	----------------------	------------	----------------	----------------	-----------

Metric

EDP	M	P	L	l	l1	d	a	Z	Type	DIN	Price
48218138	3	0,5	56	11	18	3,5	2,7	3	1	DIN371	
48218144	4	0,7	63	13	21	4,5	3,4	3	1	DIN371	
48218149	5	0,8	70	16	25	6	4,9	3	1	DIN371	
48218155	6	1	80	19	30	6	4,9	3	1	DIN371	
48218161	8	1,25	90	22	35	8	6,2	3	1	DIN371	
48218169	10	1,5	100	24	39	10	8	3	1	DIN371	
48218179	12	1,75	110	28	-	9	7	3	2	DIN376	
48218191	14	2	110	30	-	11	9	3	2	DIN376	
48218202	16	2	110	32	-	12	9	3	2	DIN376	
48218214	18	2,5	125	34	-	14	11	3	2	DIN376	
48218228	20	2,5	140	34	-	16	12	3	2	DIN376	
48218238	22	2,5	140	34	-	18	14,5	3	2	DIN376	
48218247	24	3	160	38	-	18	14,5	3	2	DIN376	

A-POT-HB Weldon

Threading | Cutting taps | Metric

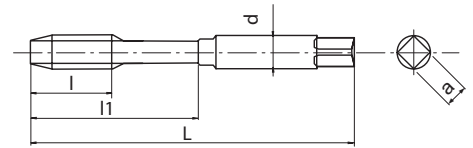

- First choice in quality and performance
- Powder metal spiral-point cutting tap for through holes
- Multilayer TiCN coating
- High speed tapping in general steels, aluminium, stainless steels
- With Weldon shank

P C < 0,2%	P 0,25 < C < 0,4	P C > 0,45%	P SCM	M INOX	N Al	N AC,ADC	S Ti	H 25-35 HRC				
15-60	15-60	10-60	8-30	8-20	15-35	15-35	5-10	8-20			m/min	

A	M	PM	V	ISO 2 6HX	B/4		DIN 371	DIN 376	DIN 1835	HB
----------	----------	-----------	----------	------------------	------------	--	----------------	----------------	-----------------	-----------

EDP	M	P	L	l	l1	d	a	Z	DIN	Price
48221138	3	0,5	56	11	18	6	4,9	3	DIN371/1835	
48221144	4	0,7	63	13	21	6	4,9	3	DIN371/1835	
48221149	5	0,8	70	16	25	6	4,9	3	DIN371/1835	
48221155	6	1	80	19	30	6	4,9	3	DIN371/1835	
48221161	8	1,25	90	22	35	8	6,2	3	DIN371/1835	
48221169	10	1,5	100	24	39	10	8	3	DIN371/1835	
48221179	12	1,75	110	28	46	12	9	3	DIN376/1835	
48221191	14	2	110	30	49	14	11	3	DIN376/1835	
48221202	16	2	110	32	56	16	12	3	DIN376/1835	



A-POT

Threading | Cutting taps | Metric Fine

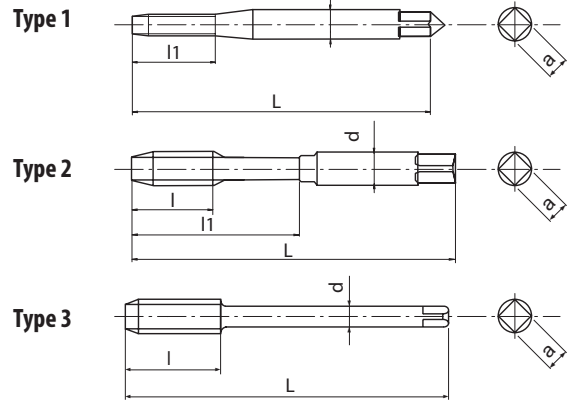

- First choice in quality and performance
- Powder metal spiral-point cutting tap for through holes
- Multilayer TiCN coating
- High speed tapping in general steels, aluminium, stainless steels

Threading | Cutting taps

P	P	P	P	M	N	N	S	H	
C < 0,2%	0,25 < C < 0,4	C > 0,45%	SCM	INOX	Al	AC,ADC	Ti	25-35 HRC	m/min
15-60	15-60	10-60	8-30	8-20	15-35	15-35	5-10	8-20	

A	MF	PM	V	ISO 2 6HX	B/4	DIN 371	DIN 374
----------	-----------	-----------	----------	------------------	------------	----------------	----------------

Metric Fine

EDP	MF	P	L	l	l1	d	a	Z	Type	DIN	Price
48145135	2,5	0,35	50	-	9	2,8	2,1	2	1	DIN371	
48145137	2,6	0,35	50	-	9	2,8	2,1	2	1	DIN371	
48145141	3	0,35	56	8	18	3,5	2,7	3	2	DIN371	
48145143	3,5	0,35	56	9	20	4	3	3	2	DIN371	
48145145	4	0,5	63	10	21	4,5	3,4	3	2	DIN371	
48145146	4	0,35	63	10	21	4,5	3,4	3	2	DIN371	
48145148	4,5	0,5	70	12	25	6	4,9	3	2	DIN371	
48145151	5	0,5	70	12	25	6	4,9	3	2	DIN371	
48145601	6	0,75	80	14	30	6	4,9	3	2	DIN371	
48145602	6	0,5	80	14	30	6	4,9	3	2	DIN371	
48145160	7	0,75	80	14	30	7	5,5	3	2	DIN371	
48145603	8	1	90	22	35	8	6,2	3	2	DIN371	
48145604	8	0,75	80	18	30	8	6,2	3	2	DIN371	
48145605	9	1	90	22	35	9	7	3	2	DIN371	
48145606	10	1,25	100	24	39	10	8	3	2	DIN371	
48145607	10	1	90	20	35	10	8	3	2	DIN371	
48145608	10	0,75	90	20	35	10	8	3	2	DIN371	
48145156	6	0,75	80	14	-	4,5	3,4	3	3	DIN374	
48145157	6	0,5	80	14	-	4,5	3,4	3	3	DIN374	
48145162	8	1	90	22	-	6	4,9	3	3	DIN374	
48145163	8	0,75	80	18	-	6	4,9	3	3	DIN374	
48145167	9	1	90	22	-	7	5,5	3	3	DIN374	
48145170	10	1,25	100	24	-	7	5,5	3	3	DIN374	
48145171	10	1	90	20	-	7	5,5	3	3	DIN374	
48145172	10	0,75	90	20	-	7	5,5	3	3	DIN374	
48145176	11	1	90	20	-	8	6,2	3	3	DIN374	
48145180	12	1,5	100	22	-	9	7	3	3	DIN374	
48145181	12	1,25	100	22	-	9	7	3	3	DIN374	
48145182	12	1	100	22	-	9	7	3	3	DIN374	
48145192	14	1,5	100	22	-	11	9	4	3	DIN374	
48145193	14	1,25	100	22	-	11	9	4	3	DIN374	
48145194	14	1	100	22	-	11	9	4	3	DIN374	
48145203	16	1,5	100	22	-	12	9	4	3	DIN374	
48145204	16	1	100	22	-	12	9	4	3	DIN374	
48145216	18	1,5	110	25	-	14	11	4	3	DIN374	
48145218	18	1	110	25	-	14	11	4	3	DIN374	
48145220	20	2	140	34	-	16	12	4	3	DIN374	
48145230	20	1,5	125	25	-	16	12	4	3	DIN374	
48145232	20	1	125	25	-	16	12	4	3	DIN374	
48145239	22	2	140	34	-	18	14,5	4	3	DIN374	
48145240	22	1,5	125	25	-	18	14,5	4	3	DIN374	
48145241	22	1	125	25	-	18	14,5	4	3	DIN374	
48145249	24	2	140	28	-	18	14,5	4	3	DIN374	
48145250	24	1,5	140	28	-	18	14,5	4	3	DIN374	
48145251	24	1	140	28	-	18	14,5	4	3	DIN374	

A-POT 6GX

Threading | Cutting taps | Metric Fine

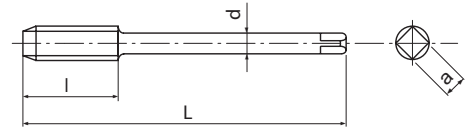

- First choice in quality and performance
- Powder metal spiral-point cutting tap for through holes
- Multilayer TiCN coating
- High speed tapping in general steels, aluminium, stainless steels
- For 6G internal thread tolerance

Threading | Cutting taps

P C < 0,2%	P 0,25 < C < 0,4	P C > 0,45%	P SCM	M INOX	N Al	N AC,ADC	S Ti	H 25-35 HRC		
15-60	15-60	10-60	8-30	8-20	15-35	15-35	5-10	8-20	m/min	

A	MF	PM	V	ISO 3 6GX	B/4	DIN 374
----------	-----------	-----------	----------	----------------------	------------	----------------

Metric Fine

EDP	MF	P	oversize	L	l	d	a	Z	DIN	Price
48205156	6	0,75	+0,022	80	14	4,5	3,4	3	DIN374	
48205162	8	1	+0,026	80	22	6	4,9	3	DIN374	
48205163	8	0,75	+0,022	80	18	6	4,9	3	DIN374	
48205170	10	1,25	+0,028	90	24	7	5,5	3	DIN374	
48205171	10	1	+0,026	90	20	7	5,5	3	DIN374	
48205180	12	1,5	+0,032	90	22	9	7	3	DIN374	
48205181	12	1,25	+0,028	90	22	9	7	3	DIN374	
48205182	12	1	+0,026	90	22	9	7	3	DIN374	
48205192	14	1,5	+0,032	90	22	11	9	4	DIN374	
48205203	16	1,5	+0,032	100	22	12	9	4	DIN374	
48205216	18	1,5	+0,032	100	25	14	11	4	DIN374	
48205230	20	1,5	+0,032	140	25	16	12	4	DIN374	
48205240	22	1,5	+0,032	140	25	18	14,5	4	DIN374	
48205250	24	1,5	+0,032	140	28	18	14,5	4	DIN374	

A-POT

Threading | Cutting taps | UNC



Type 1

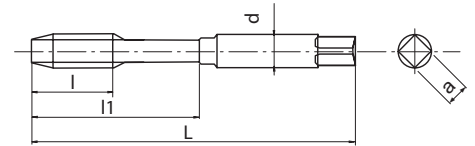

Type 2

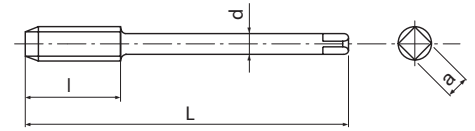

- First choice in quality and performance
- Powder metal spiral-point cutting tap for through holes
- Multilayer TiCN coating
- High speed tapping in general steels, aluminium, stainless steels

P C < 0,2%	P 0,25 < C < 0,4	P C > 0,45%	P SCM	M INOX	N Al	N AC,ADC	S Ti	H 25-35 HRC	
15-60	15-60	10-60	8-30	8-20	15-35	15-35	5-10	8-20	m/min

A	UNC	PM	V	ANSI 2BX	B/4	DIN 2184-1	DIN 2184-1
----------	------------	-----------	----------	-----------------	------------	-------------------	-------------------

EDP	UNC	P	L	l	l1	d	a	Z	Type	DIN	Price
48145453	2	56	45	-	9	2,8	2,1	2	1	DIN2184-1	
48145455	3	48	50	-	9	2,8	2,1	2	1	DIN2184-1	
48145457	4	40	56	11	18	3,5	2,7	2	1	DIN2184-1	
48145459	5	40	56	11	18	3,5	2,7	3	1	DIN2184-1	
48145461	6	32	56	12	20	4	3	3	1	DIN2184-1	
48145464	8	32	63	13	21	4,5	3,4	3	1	DIN2184-1	
48145466	10	24	70	16	25	6	4,9	3	1	DIN2184-1	
48145468	12	24	80	17	30	6	4,9	3	1	DIN2184-1	
48145471	1/4	20	80	19	30	7	5,5	3	1	DIN2184-1	
48145474	5/16	18	90	22	35	8	6,2	3	1	DIN2184-1	
48145479	3/8	16	100	24	39	10	8	3	1	DIN2184-1	
48145484	7/16	14	100	24	-	8	6,2	3	2	DIN2184-1	
48145489	1/2	13	110	28	-	9	7	3	2	DIN2184-1	
48145494	9/16	12	110	30	-	11	9	3	2	DIN2184-1	
48145501	5/8	11	110	32	-	12	9	3	2	DIN2184-1	
48145515	3/4	10	125	34	-	14	11	3	2	DIN2184-1	
48145526	7/8	9	140	34	-	18	14,5	3	2	DIN2184-1	
48145538	1	8	160	38	-	18	14,5	3	2	DIN2184-1	



A-POT

Threading | Cutting taps | UNF

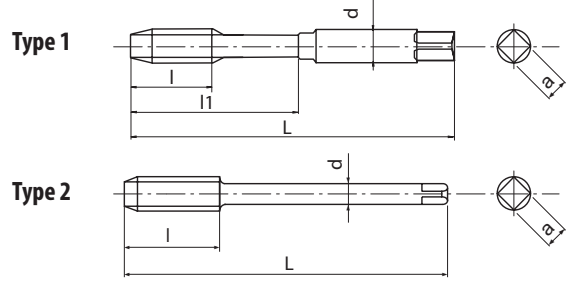
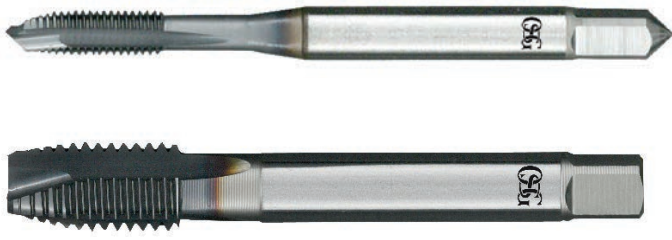

- First choice in quality and performance
- Powder metal spiral-point cutting tap for through holes
- Multilayer TiCN coating
- High speed tapping in general steels, aluminium, stainless steels

Threading | Cutting taps

P C < 0,2%	P 0,25 < C < 0,4	P C > 0,45%	P SCM	M INOX	N Al	N AC,ADC	S Ti	H 25-35 HRC		
15-60	15-60	10-60	8-30	8-20	15-35	15-35	5-10	8-20		m/min



UNF

EDP	UNF	P	L	l	l1	d	a	Z	Type	DIN	Price
48145454	2	64	45	-	9	2,8	2,1	2	1	DIN2184-1	
48145456	3	56	50	-	9	2,8	2,1	2	1	DIN2184-1	
48145458	4	48	56	11	18	3,5	2,7	2	1	DIN2184-1	
48145460	5	44	56	11	18	3,5	2,7	3	1	DIN2184-1	
48145462	6	40	56	12	20	4	3	3	1	DIN2184-1	
48145465	8	36	63	13	21	4,5	3,4	3	1	DIN2184-1	
48145467	10	32	70	16	25	6	4,9	3	1	DIN2184-1	
48145469	12	28	80	17	30	6	4,9	3	1	DIN2184-1	
48145472	1/4	28	80	19	30	7	5,5	3	1	DIN2184-1	
48145476	5/16	24	90	22	35	8	6,2	3	1	DIN2184-1	
48145481	3/8	24	90	20	35	10	8	3	1	DIN2184-1	
48145486	7/16	20	100	24	-	8	6,2	3	2	DIN2184-1	
48145491	1/2	20	100	22	-	9	7	3	2	DIN2184-1	
48145496	9/16	18	100	22	-	11	9	3	2	DIN2184-1	
48145504	5/8	18	100	22	-	12	9	3	2	DIN2184-1	
48145517	3/4	16	110	25	-	14	11	3	2	DIN2184-1	
48145528	7/8	14	125	25	-	18	14,5	3	2	DIN2184-1	
48145539	1	12	140	28	-	18	14,5	3	2	DIN2184-1	

A-POT

Threading | Cutting taps | G (BSP)

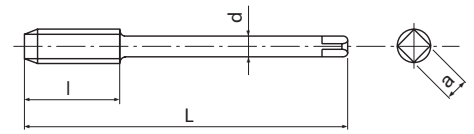

- First choice in quality and performance
- Powder metal spiral-point cutting tap for through holes
- Multilayer TiCN coating
- High speed tapping in general steels, aluminium, stainless steels

P	P	P	P	M	N	N	S	H	
C < 0,2%	0,25 < C < 0,4	C > 0,45%	SCM	INOX	Al	AC,ADC	Ti	25-35 HRC	
15-60	15-60	10-60	8-30	8-20	15-35	15-35	5-10	8-20	m/min

A

G

PM

V

B/4

DIN 5156

EDP	G	P	L	l	d	a	Z	DIN	Price
48145900	1/8	28	90	20	7	5,5	3	DIN5156	
48145000	1/4	19	100	22	11	9	3	DIN5156	
48145100	3/8	19	100	22	12	9	3	DIN5156	
48145200	1/2	14	125	25	16	12	3	DIN5156	
48145300	5/8	14	125	25	18	14,5	4	DIN5156	
48145400	3/4	14	140	28	20	16	4	DIN5156	
48145500	7/8	14	150	28	22	18	4	DIN5156	
48145600	1	11	160	30	25	20	4	DIN5156	

Threading | Cutting taps
G (BSP)



A-POT

Threading | Cutting taps | BSW

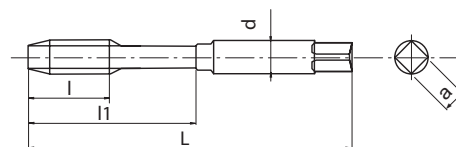
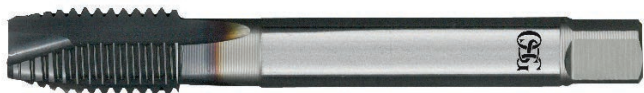

- First choice in quality and performance
- Powder metal spiral-point cutting tap for through holes
- Multilayer TiCN coating
- High speed tapping in general steels, aluminium, stainless steels

P C < 0,2%	P 0,25 < C < 0,4	P C > 0,45%	P SCM	M INOX	N Al	N AC,ADC	S Ti	H 25-35 HRC	
15-60	15-60	10-60	8-30	8-20	15-35	15-35	5-10	8-20	m/min

A	BSW	PM	V	MED	B/4	DIN 2184-1
----------	------------	-----------	----------	------------	------------	-------------------

EDP	BSW	TPI	L	l	l1	d	a	Z	DIN	Price
48205702	1/8	40	56	11	18	3,5	2,7	3	DIN2184-1	
48205704	3/16	24	70	16	25	6	4,9	3	DIN2184-1	
48205706	1/4	20	80	19	30	7	5,5	3	DIN2184-1	
48205707	5/16	18	90	22	35	8	6,2	3	DIN2184-1	
48205708	3/8	16	100	24	39	10	8	3	DIN2184-1	
48205709	7/16	14	100	24	-	8	6,2	3	DIN2184-1	
48205710	1/2	12	110	28	-	9	7	3	DIN2184-1	
48205712	5/8	11	110	32	-	12	9	3	DIN2184-1	
48205713	3/4	10	125	34	-	14	11	3	DIN2184-1	
48205714	7/8	9	140	34	-	18	14,5	3	DIN2184-1	
48205715	1	8	160	38	-	18	14,5	3	DIN2184-1	

Threading | Cutting taps

BSW

A-POT

Threading | Cutting taps | BSF

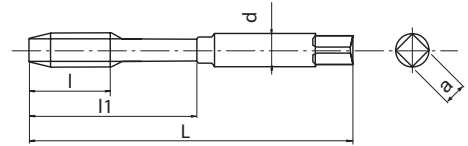

- First choice in quality and performance
- Powder metal spiral-point cutting tap for through holes
- Multilayer TiCN coating
- High speed tapping in general steels, aluminium, stainless steels

P C < 0,2%	P 0,25 < C < 0,4	P C > 0,45%	P SCM	M INOX	N Al	N AC,ADC	S Ti	H 25-35 HRC	
15-60	15-60	10-60	8-30	8-20	15-35	15-35	5-10	8-20	m/min

A
BSF
PM
V
MED
B/4
DIN 2184-1

EDP	BSF	TPI	L	l	l1	d	a	Z	DIN	Price
48205731	1/4	26	80	19	30	7	5,5	3	DIN2184-1	
48205732	5/16	22	90	22	35	8	6,2	3	DIN2184-1	
48205733	3/8	20	100	24	39	10	8	3	DIN2184-1	
48205734	7/16	18	100	24	-	8	6,2	3	DIN2184-1	
48205735	1/2	16	100	22	-	9	7	3	DIN2184-1	
48205737	5/8	14	110	32	-	12	9	3	DIN2184-1	
48205739	3/4	12	125	34	-	14	11	3	DIN2184-1	
48205742	1	10	160	38	-	18	14,5	3	DIN2184-1	

A-POT

Threading | Cutting taps | BA

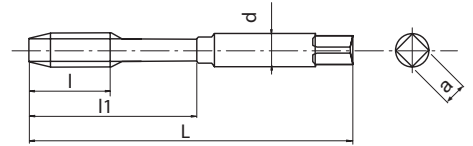

- First choice in quality and performance
- Powder metal spiral-point cutting tap for through holes
- Multilayer TiCN coating
- High speed tapping in general steels, aluminium, stainless steels

Threading | Cutting taps

P C < 0,2%	P 0,25 < C < 0,4	P C > 0,45%	P SCM	M INOX	N Al	N AC, ADC	S Ti	H 25-35 HRC		
15-60	15-60	10-60	8-30	8-20	15-35	15-35	5-10	8-20		m/min

A	BA (BS93)	PM	V	B/4	
----------	---------------------	-----------	----------	------------	--

EDP	BA	L	l	l1	d	a	Z	Price
48205910	0	66	19	30	6,3	5	3	
48205911	1	62	17	26	5,6	4,5	3	
48205912	2	58	16	25	5	4	3	
48205913	3	53	13	21	4,5	3,55	3	
48205914	4	50	13	20	3,55	2,8	3	
48205915	5	48	11	18	3,15	2,5	3	
48205916	6	44,5	9,5	-	2,8	2,24	2	
48205917	7	44,5	9,5	-	2,8	2,24	2	
48205918	8	44,5	9,5	-	2,8	2,24	2	
48205919	9	41	8	-	2,5	2	2	
48205920	10	41	8	-	2,5	2	2	
48205921	11	41	8	-	2,5	2	2	
48205922	12	40	7	-	2,5	2	2	



BA



www.osgeurope.com



SWEDEN

Branch office of OSG SCANDINAVIA
Abrahams Gränd 8
295 35 Bromölla
Sweden
Tel: +46 40 41 22 55
Fax: +46 40 41 32 55
osg@osg-scandinavia.com

OSG SCANDINAVIA

(For Scandinavian countries)
Langebjergvaenget 16
4000 Roskilde
Denmark
Tel.: +45 46 75 65 55
Fax: +45 46 75 67 00
osg@osg-scandinavia.com

OSG NETHERLANDS

Bedrijfsweg 5 - 3481 MG Harmelen
Postbus 50 - 3480 DB Harmelen
The Netherlands
Tel.: +31 348 44 2764
Fax: +31 348 44 2144
info@osg-nl.com

OSG UK

Shelton house, 5 Bentalls
Pipps Hill Ind Est, Basildon Essex SS14 3BY
United Kingdom
Tel.: +44 845 305 1066
Fax: +44 845 305 1067
sales@osg-uk.com

OSG EUROPE LOGISTICS

Avenue Lavoisier 1
B-1300 Z.I. Wavre - Nord
Belgium
Tel.: +32 10 23 05 07
Fax: +32 10 23 05 11
info@osgeurope.com

OSG BELUX

Avenue Lavoisier 1
B-1300 Z.I. Wavre - Nord
Belgium
Tel.: +32 10 23 05 11
Fax: +32 10 23 05 31
info@osg-belgium.com

OSG IBERICA

Bekolarra 4
E - 01010 Vitoria-Gasteiz
Spain
Tel.: +34 945 242 400
Fax: +34 945 228 883
osg.iberica@osg-ib.com

OSG FRANCE

Parc Icade, Paris Nord 2
Immeuble "Le Rimbaud"
22 Avenue des Nations
CS66191 - 93420 Villepinte
France
Tel.: +33 1 49 90 10 10
Fax: +33 1 49 90 10 15
sales@osg-france.com





SLOVAKIA

Branch office of OSG Belgium s.a.
Tel: +32 10 23 05 04
Fax: +32 10 23 05 31
info@osg-belgium.com

OSG POLAND

Spółdzielcza 57
05-074 Halinów
Poland

OSG RUSSIA

Butlerova street, 17B, office 5069
117342 Moscow
Russia
Tel: +7 (495) 150 41 54
info@osg-russia.com

ROMSAN INTERNATIONAL CO. SRL

Reprezentant Exclusiv OSG
23-25, Nerva Traian Street
031044 Bucuresti
România
Tel: +40 021 322 07 47
Fax: +40 021 321 56 00
romsan.int@romsan.ro

OSG TURKEY

Rami Kişla Cad.No:56 Eyüp
Istanbul 34056
Turkey
Tel.+90 212 565 24 00
Fax: +90 212 565 44 00
info@osg-turkey.com

OSG ITALIA

Via Cirenaiica n. 52 int. 61/63
I - 10142 Torino
Italy
Tel.: +39 0117705211
Fax: +39 0117071402
info@osg-italia.it

OSG GERMANY

Karl-Ehmann-Str. 25
D - 73037 Göppingen
Germany
Tel.: +49 7161 6064 - 0
Fax: +49 7161 6064 - 444
info@osg-germany.de



shaping your dreams

OSG EUROPE LOGISTICS

Avenue Lavoisier 1
B-1300 Z.I. Wavre - Nord - Belgium
Tel: +32 10 23 05 07
Fax: +32 10 23 05 51
info@osgeurope.com

OSG BELUX

Avenue Lavoisier 1
B-1300 Z.I. Wavre - Nord - Belgium
Tel: +32 10 23 05 11
Fax: +32 10 23 05 31
info@osg-belgium.com

OSG FRANCE

Parc Icade, Paris Nord 2
Immeuble "Le Rimbaud"
22 Avenue des Nations
CS66191 - 93420 Villepinte - France
Tel: +33 1 49 90 10 10
Fax: +33 1 49 90 10 15
sales@osg-france.com

OSG NETHERLANDS

Bedrijfsweg 5 - 3481 MG Harmelen
Tel: +31 348 44 2764
Fax: +31 348 44 2144
info@osg-nl.com

OSG UK

Shelton house, 5 Bentalls
Pipps Hill Ind Est, Basildon Essex SS14 3BY
Tel: +44 845 305 1066
Fax: +44 845 305 1067
sales@osg-uk.com

SLOVAKIA

Branch office of OSG Europe Logistics s.a.
Tel (SK) +421 2 4329 1295
Tel (BE) +32 10 23 05 07
Fax (BE) +32 10 23 05 51
sales-osgsvk@osgeurope.com

OSG POLAND Sp. z.o.o.

Spółdzielcza 57
05-074 Halinów - Poland
Tel: +22 760 82 71
Fax: +22 760 82 71
osg@osg-poland.com

OSG GERMANY

Karl-Ehmann-Str. 25
D - 73037 Göppingen - Germany
Tel: +49 7161 6064 - 0
Fax: +49 7161 6064 - 444
info@osg-germany.de

OSG SCANDINAVIA

(For Scandinavian countries)
Langebjergvaenget 16
4000 Roskilde - Denmark
Tel: +45 46 75 65 55
Fax: +45 46 75 67 00
osg@osg-scandinavia.com

SWEDEN

Branch office of OSG SCANDINAVIA
Abrahams Gränd 8
295 35 Bromölla - Sweden
Tel: +46 40 41 22 55
Fax: +46 40 41 32 55
osg@osg-scandinavia.com

OSG IBERICA

Bekolarra 4
E - 01010 Vitoria-Gasteiz - Spain
Tel: +34 945 242 400
Fax: +34 945 228 883
osg.iberica@osg-ib.com

RUSSIA

Butlerova street, 17B, office 5069
117342 Moscow - Russia
Tel: +7 (495) 150 41 54
info@osg-russia.com

OSG TURKEY

Rami Kişla Cad.No:56 Eyüp
Istanbul 34056 - Turkey
Tel:+90 212 565 24 00
Fax: +90 212 565 44 00
info@osg-turkey.com

ROMSAN INTERNATIONAL CO. SRL

Reprezentant Exclusiv OSG
23-25, Nerva Traian Street
031044 Bucuresti - România
Tel: +40 021 322 07 47
Fax: +40 021 321 56 00
romsan.int@romsan.ro

AUSTRIA

Branch office of OSG GERMANY
Messestraße 11
A-6850 Dornbirn
Tel: +49 7161 6064-0
Fax: +49 7161 6064-444
info@osg-germany.de

OSG ITALIA

Via Cirenaiica n. 52 int. 61/63
I - 10142 Torino - Italy
Tel: +39 0117705211
Fax: +39 0117071402
info@osg-italia.it

Vischer & Bolli AG

Im Schossacher 17
CH-8600 Dübendorf
Schweiz
Tel.: +41 44 802 15 15
Fax: +41 44 802 15 95
info@vb-tools.com

OSG EUROPE LOGISTICS S.A.

04/2018 - All rights reserved. © OSG Europe 2018.

The contents of this catalogue are provided to you for viewing only. They are not intended for reproduction either in part or in whole in this or other medium. They cannot be copied, used to create derivation work or used for any reason, by means without the express, written permission of the copyright owner. If prices are stated, they are netto unit-prices and any eventual tax(es) have to be added. The company is not responsible for any printing error in technical, price and/or any other data.

Tool specifications subject to change without notice.

www.osgeurope.com